

Panorama Locations

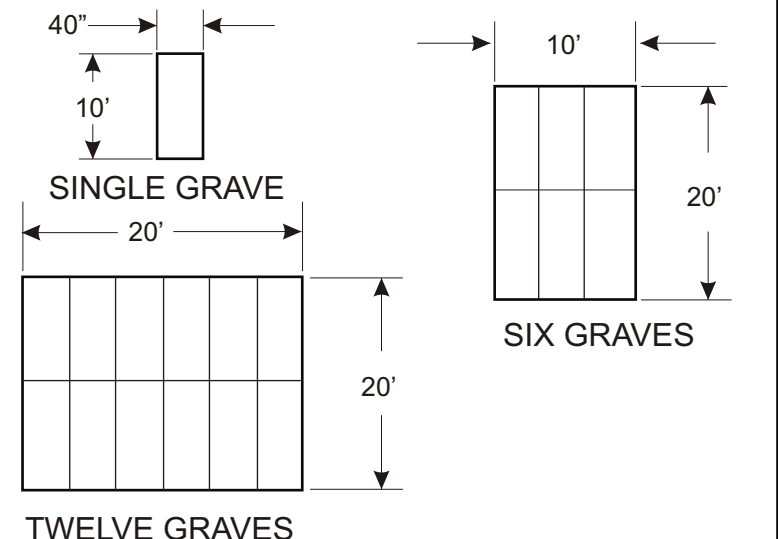
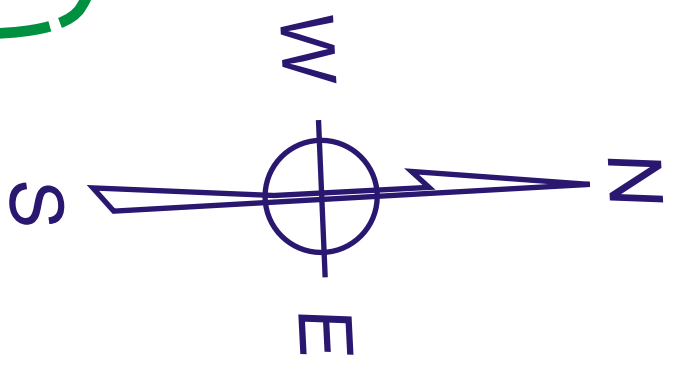

EXISTING LOT DIMENSIONING TYPICAL

<b>Old Pine Grove Cemetery</b>	
<b>OVERVIEW</b>	
NOTE: The scale, grave location and measurements shown are for general reference use only. This is not a site surveyed document.	Scale 1" = 3'
Sheet 1 of 6	
Copyright © 2004 by topoGraphix®	

Disclaimer: The contained on this map is based on documents and information supplied by the client. Accuracy of images is not suitable for engineering purposes. topoGraphix assumes no responsibility for it's content.

Tree Line

Tree Line

Tree Line

Fence Line

Fence Line

Fence Line

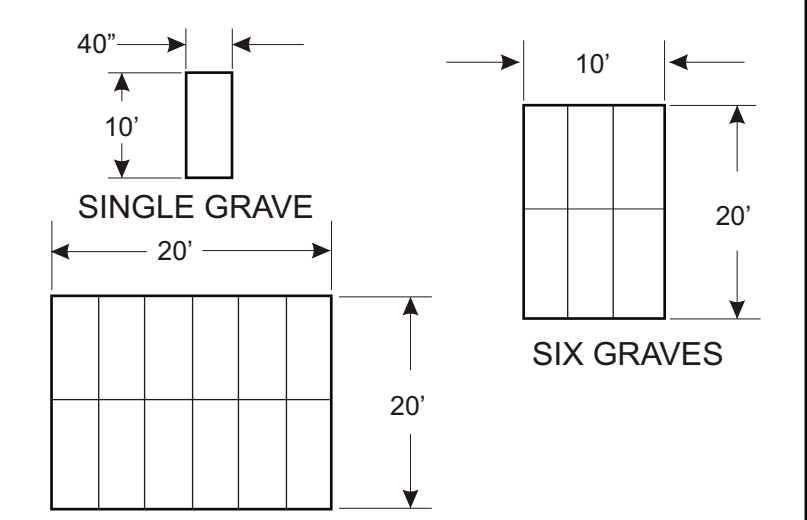
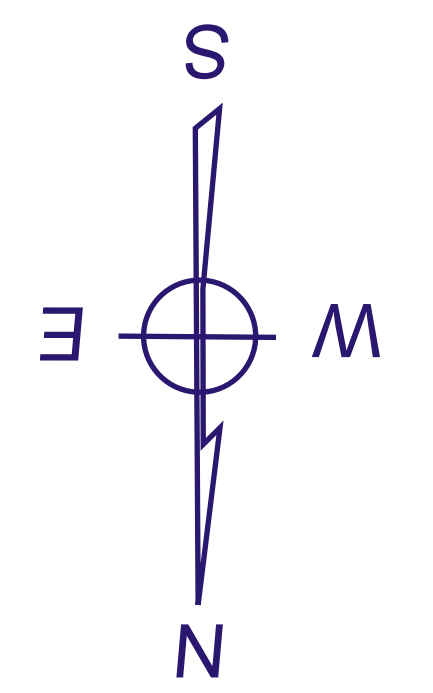
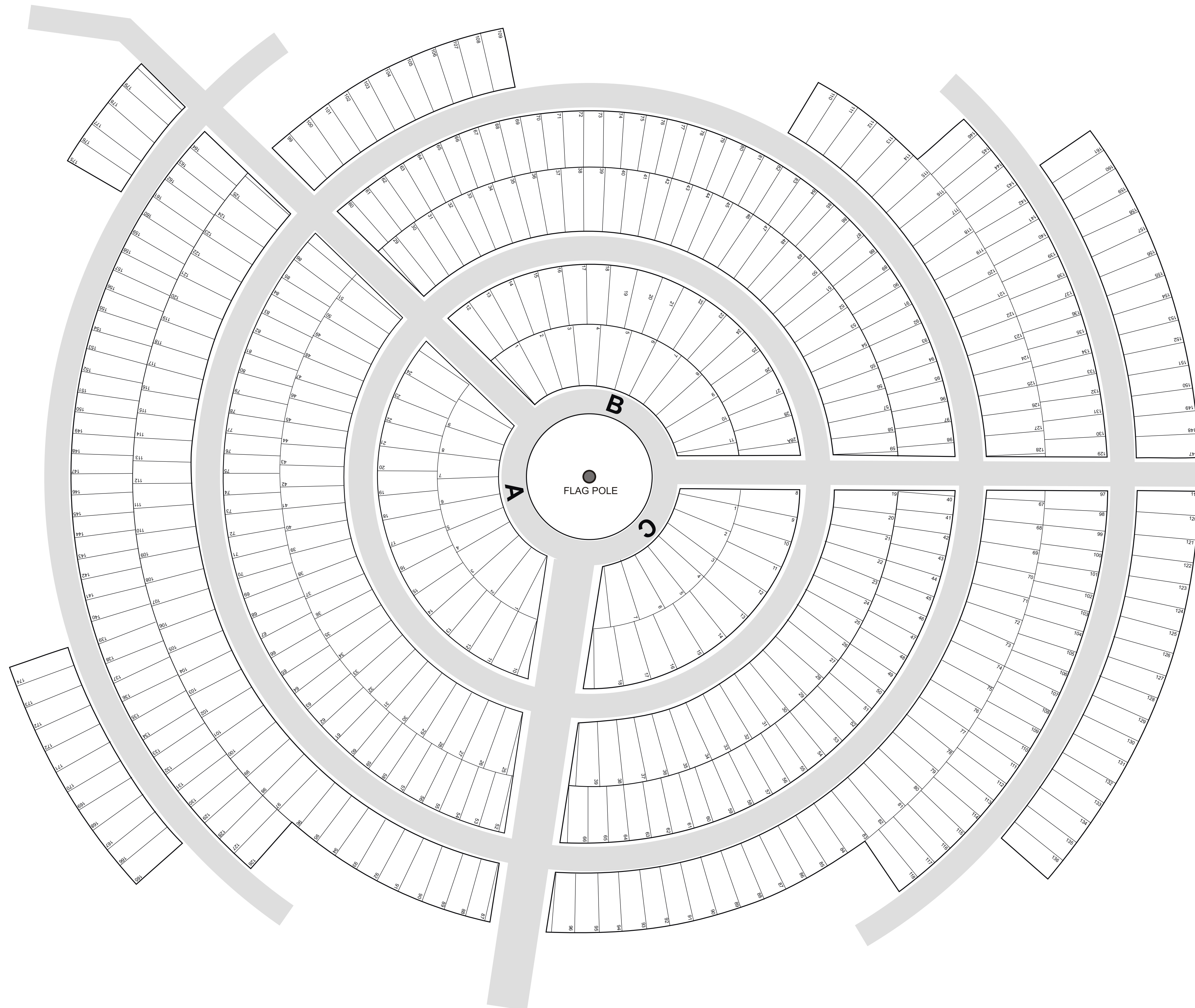

**TWELVE GRAVES**  
 Disclaimer: The contained on this map is based on documents and information supplied by the client. Accuracy of images is not suitable for engineering purposes. topoGraphix assumes no responsibility for it's content.

<b>Old Pine Grove Cemetery</b>	
Circle Sections A B & C	
NOTE: The scale, grave location and measurements shown are for general reference use only. This is not a site surveyed document.	Scale 1"= 10'
Sheet 2 of 6	
Copyright © 2004 by topoGraphix®	

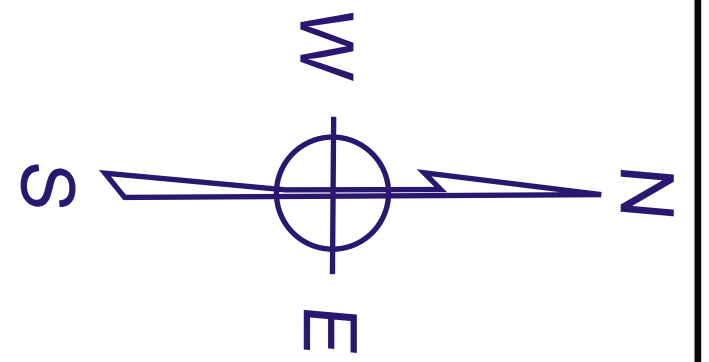
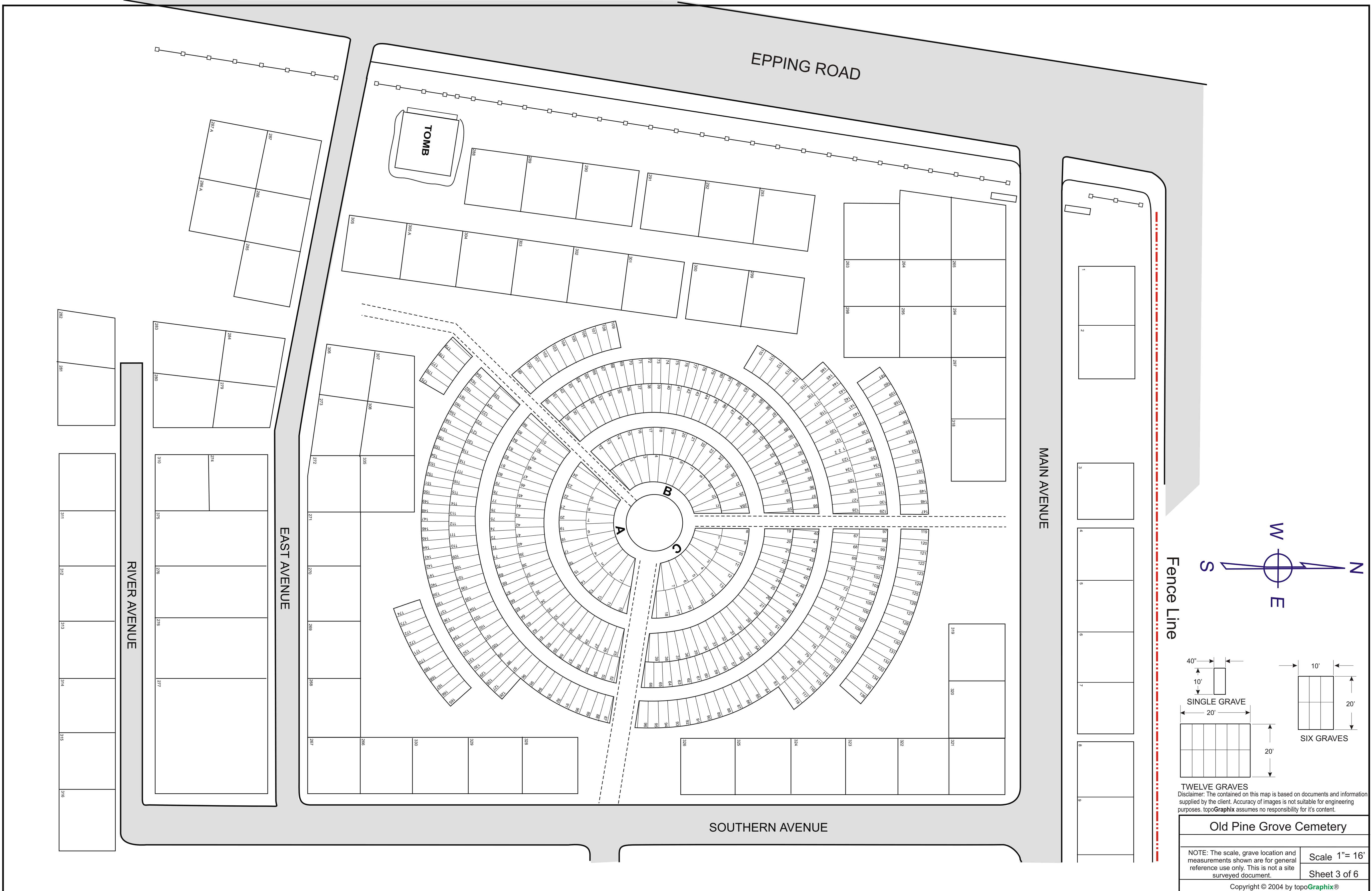

Fence Line

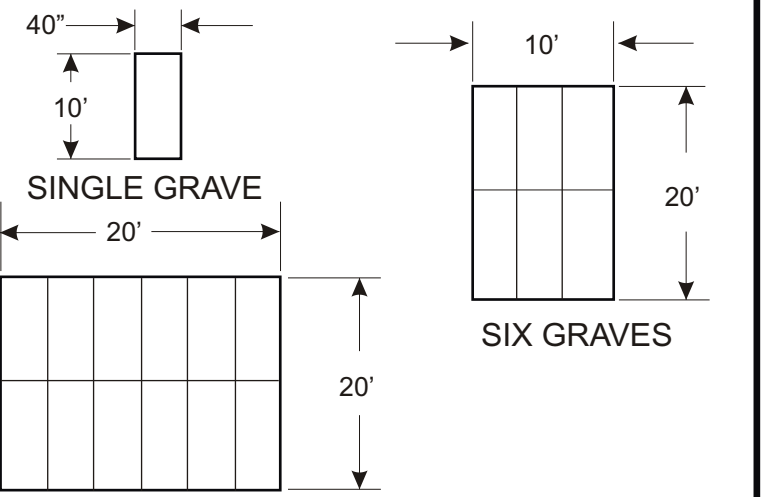

**TWELVE GRAVES**  
 Disclaimer: The contained on this map is based on documents and information supplied by the client. Accuracy of images is not suitable for engineering purposes. topoGraphix assumes no responsibility for it's content.

<b>Old Pine Grove Cemetery</b>	
NOTE: The scale, grave location and measurements shown are for general reference use only. This is not a site surveyed document.	Scale 1"= 16' Sheet 3 of 6
Copyright © 2004 by topoGraphix®	

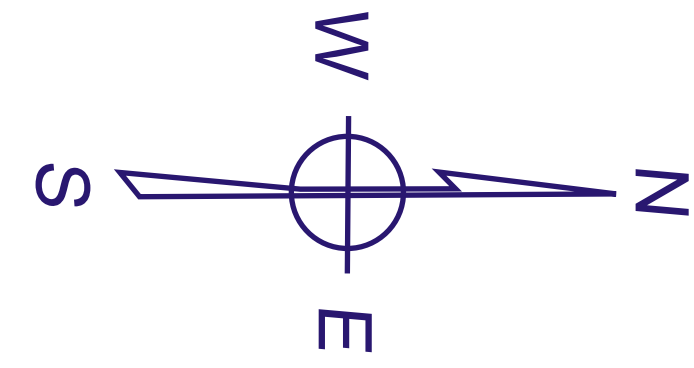
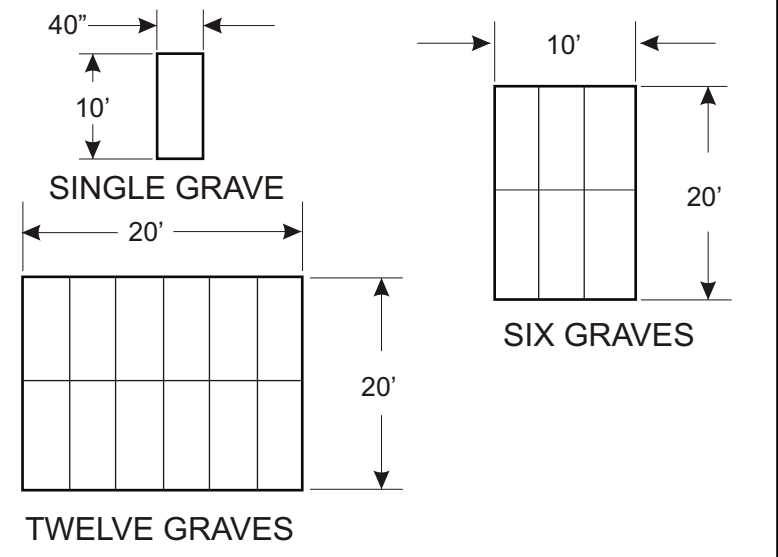
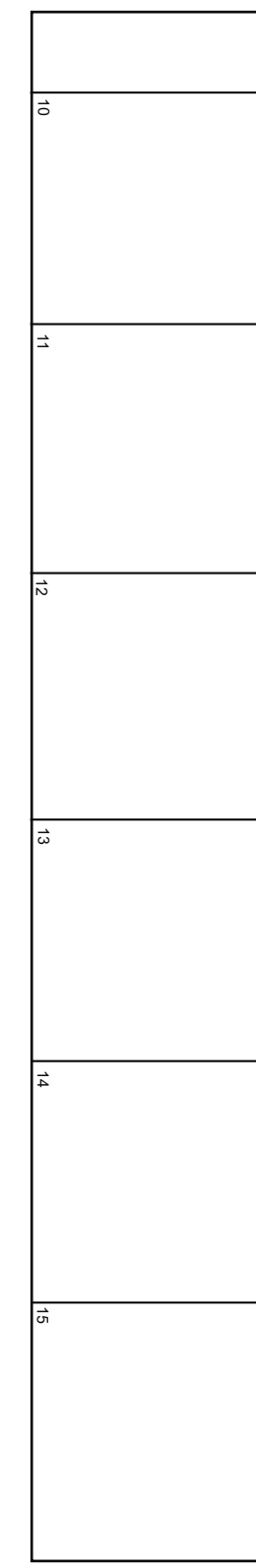
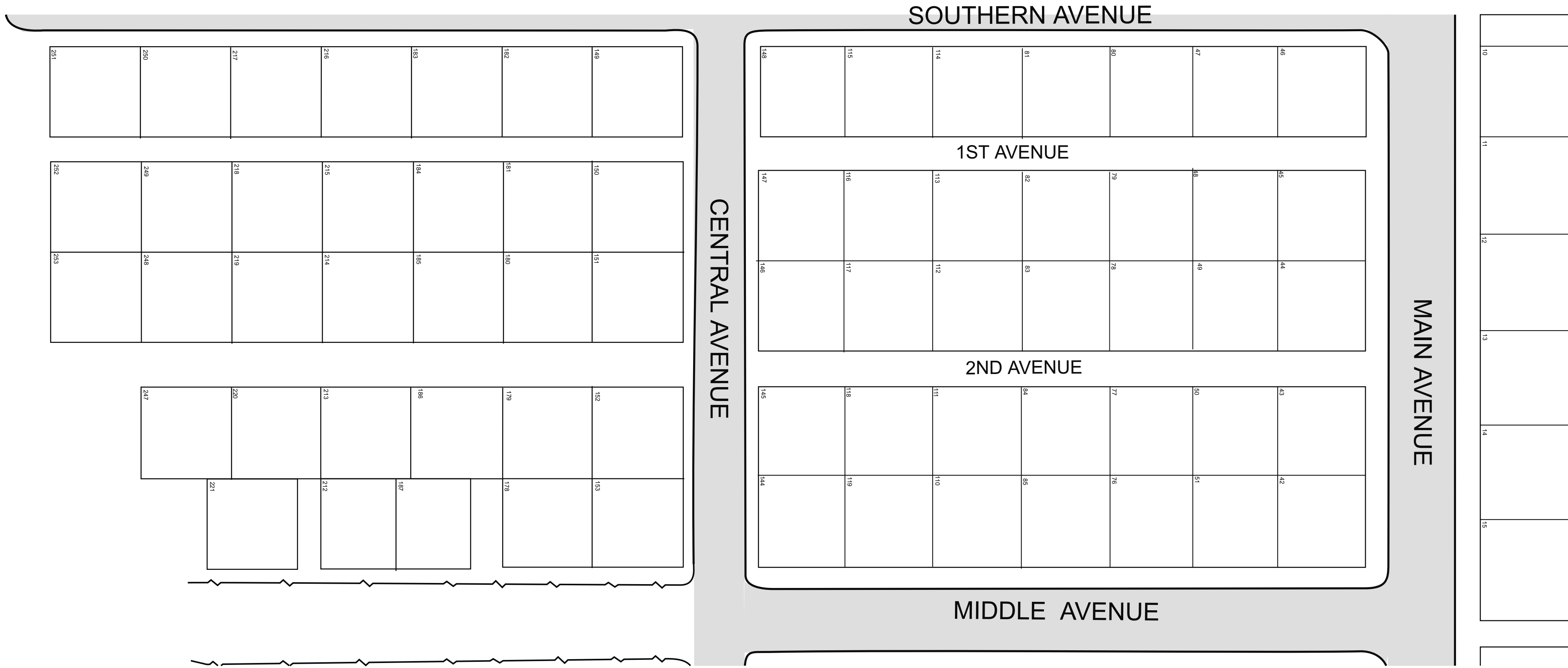

**Old Pine Grove Cemetery**

---

NOTE: The scale, grave location and measurements shown are for general reference use only. This is not a site surveyed document.

Scale 1" = 16'  
Sheet 4 of 6

Copyright © 2004 by topoGraphix®

Disclaimer: The contained on this map is based on documents and information supplied by the client. Accuracy of images is not suitable for engineering purposes. topoGraphix assumes no responsibility for it's content.

MIDDLE AVENUE

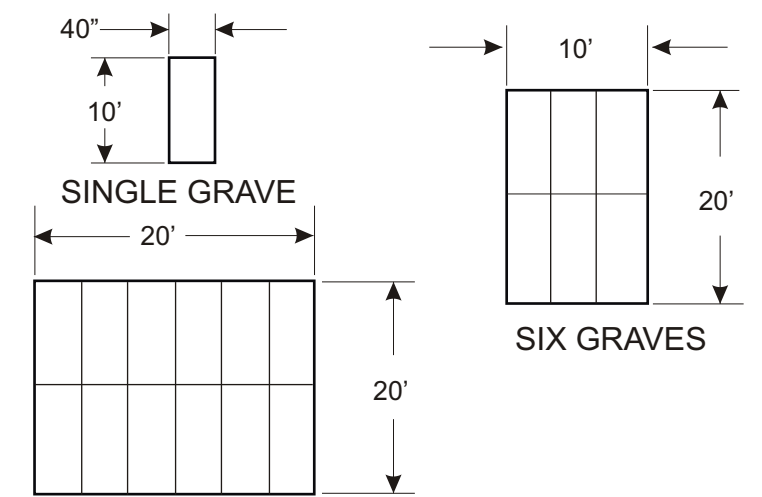
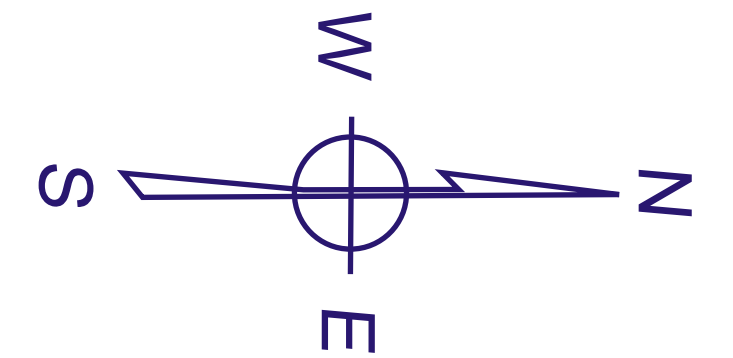
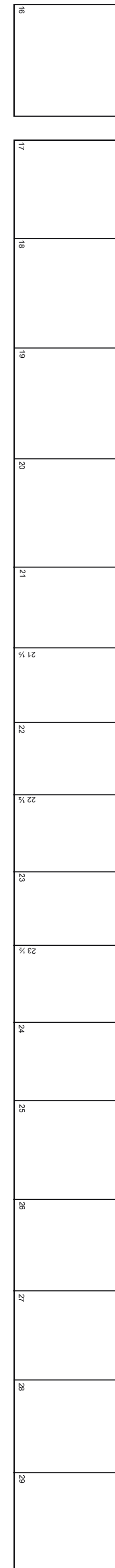

**TWELVE GRAVES**  
 Disclaimer: The contained on this map is based on documents and information supplied by the client. Accuracy of images is not suitable for engineering purposes. topoGraphix assumes no responsibility for it's content.

Old Pine Grove Cemetery

NOTE: The scale, grave location and measurements shown are for general reference use only. This is not a site surveyed document.

Scale 1"= 16'

Sheet 5 of 6

Copyright © 2004 by topoGraphix®

NORTHERN AVENUE

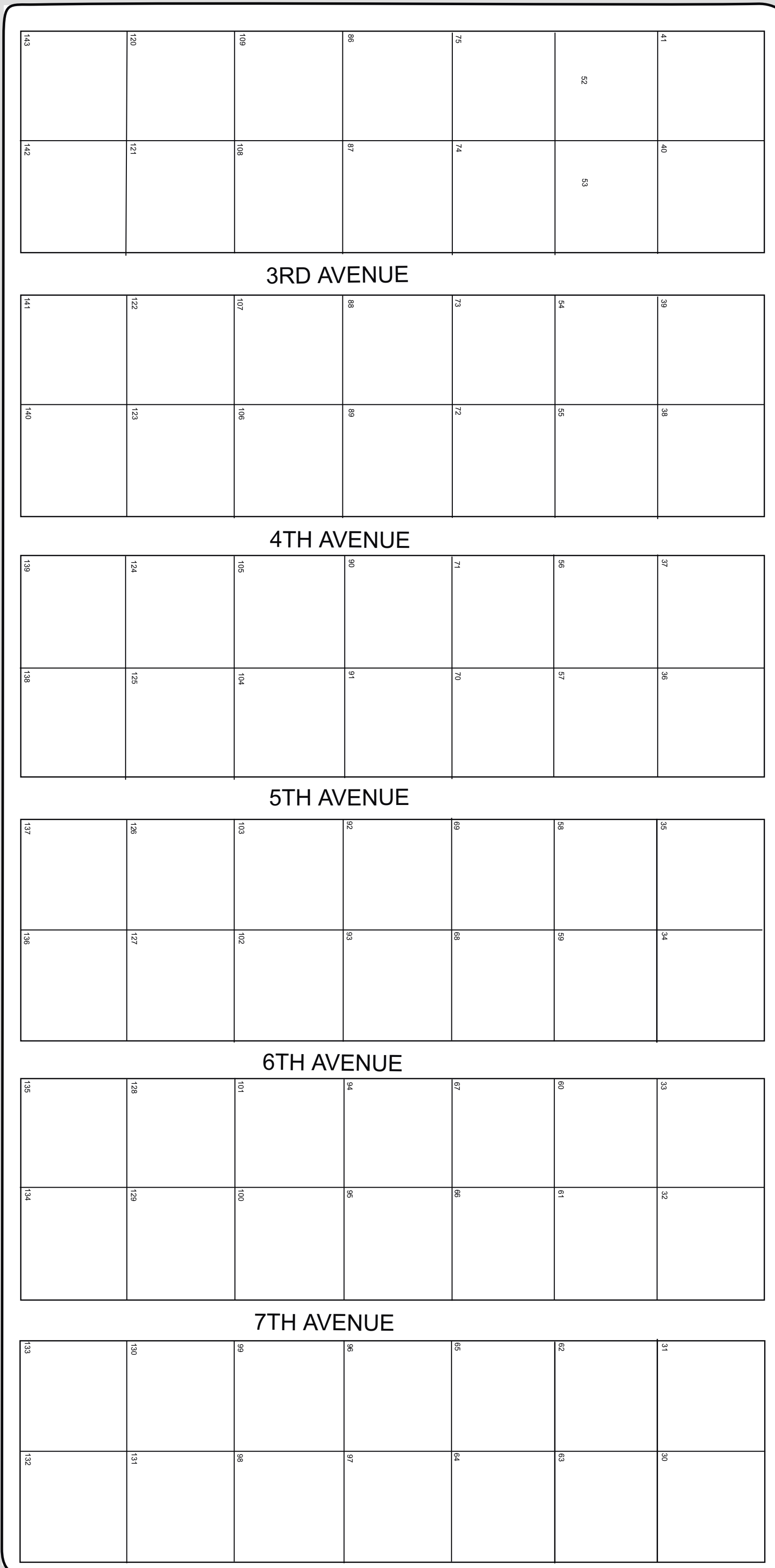

CENTRAL AVENUE

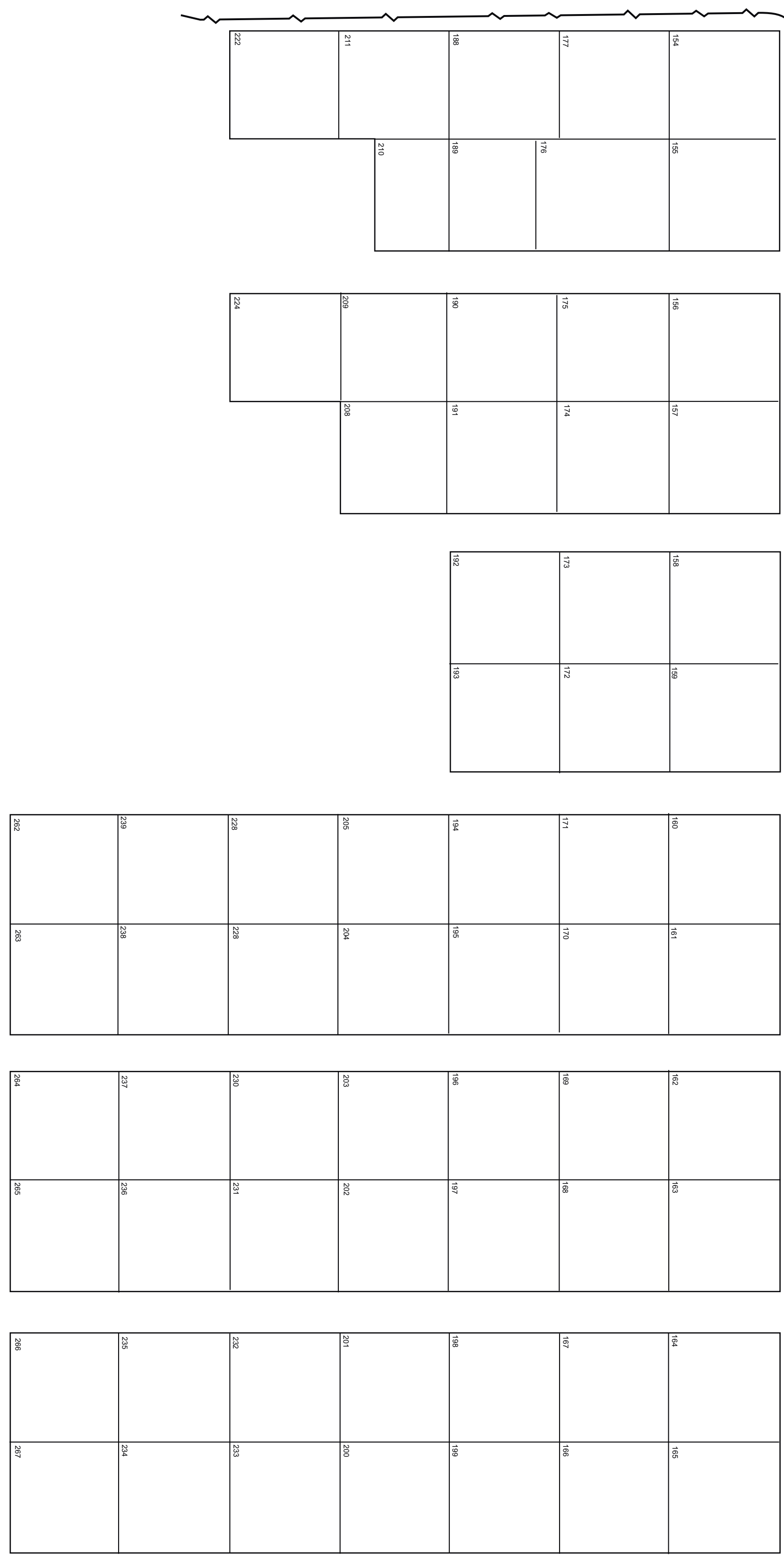

MAIN AVENUE

#?

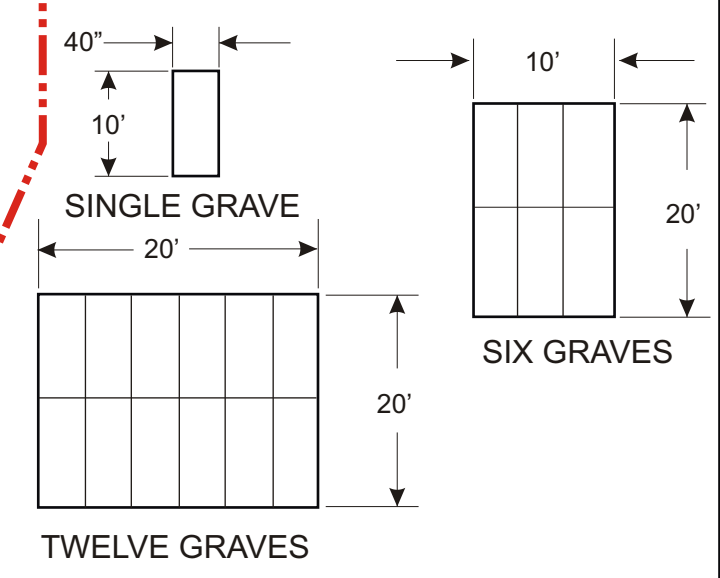
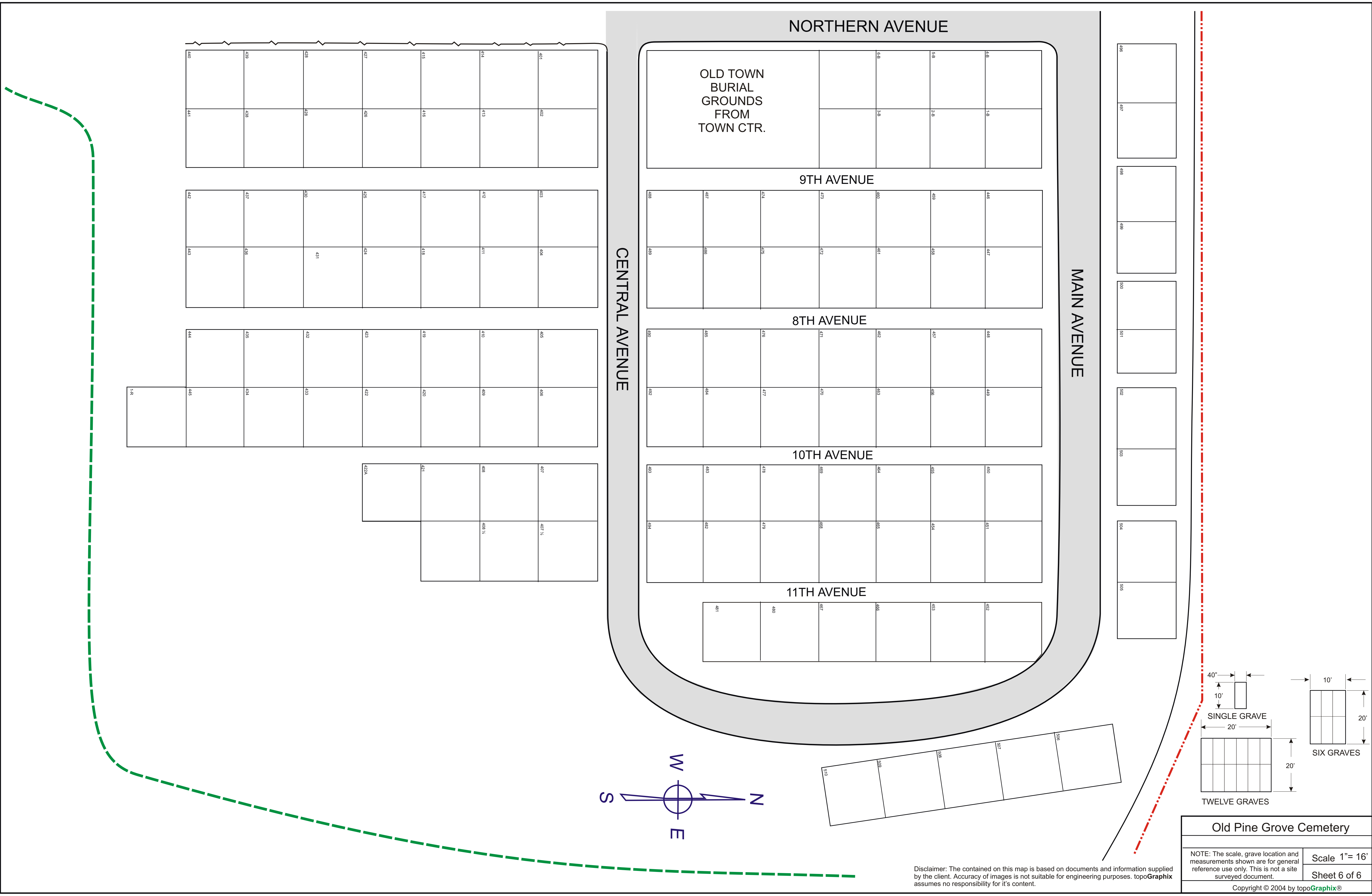

**Old Pine Grove Cemetery**

NOTE: The scale, grave location and measurements shown are for general reference use only. This is not a site surveyed document.

Scale 1"= 16'

Sheet 6 of 6

Copyright © 2004 by topoGraphix®

Disclaimer: The contained on this map is based on documents and information supplied by the client. Accuracy of images is not suitable for engineering purposes. topoGraphix assumes no responsibility for it's content.